

PNP EPITAXIAL TRANSISTOR

DESCRIPTION

The UTC TIP127 is a PNP epitaxial transistor, designed for use in general purpose amplifier low-speed switching applications.

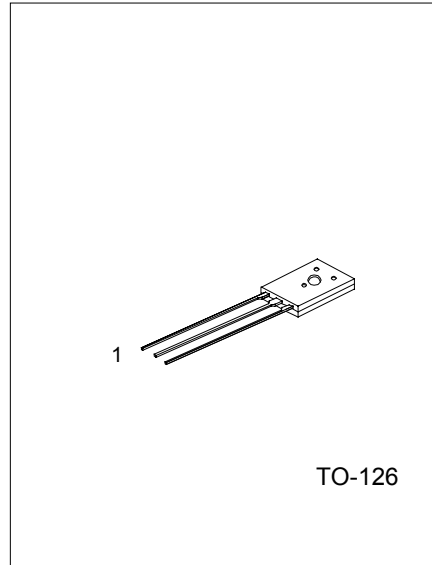

1:EMITTER 2:COLLECTOR 3:BASE

ABSOLUTE MAXIMUM RATINGS (Ta=25°C)

PARAMETER	SYMBOL	RATINGS	UNIT
Collector to Base Voltage	V_{CBO}	100	V
Collector to Emitter Voltage	V_{CEO}	100	V
Emitter to Base Voltage	V_{EBO}	5	V
Collector Current	I_C	5	A
Collector Dissipation	P_C	40	W
Storage Temperature	T_{stg}	-55 ~ +150	°C
Junction Temperature	T_J	150	°C

ELECTRICAL CHARACTERISTICS (Ta=25°C, unless otherwise specified)

PARAMETER	SYMBOL	TEST CONDITIONS	MIN.	TYP.	MAX.	UNIT
Collector-Emitter Breakdown Voltage	BV_{CEO}	$I_C=100mA$	100			V
Collector Cut-Off Current	I_{CBO}	$V_{CB}=100V$			200	uA
Collector-Cut-Off Current	I_{CEO}	$V_{CE}=50V$			500	uA
Emitter Cut-Off Current	I_{EBO}	$V_{EB}=5V$			2	mA
Collector-Emitter Saturation Voltage	$V_{CE(SAT)1}$	$I_C=3A, I_B=12mA$			2	V
Collector-Emitter Saturation Voltage	$V_{CE(SAT)2}$	$I_C=5A, I_B=20mA$			4	V
Base-Emitter Saturation Voltage	$V_{BE(ON)}$	$V_{CE}=3V, I_C=3A$			2.5	V
DC Current Gain	h_{FE}	$I_C=500mA, V_{CE}=3V$ $I_C=3A, V_{CE}=3V$	1000 1000			

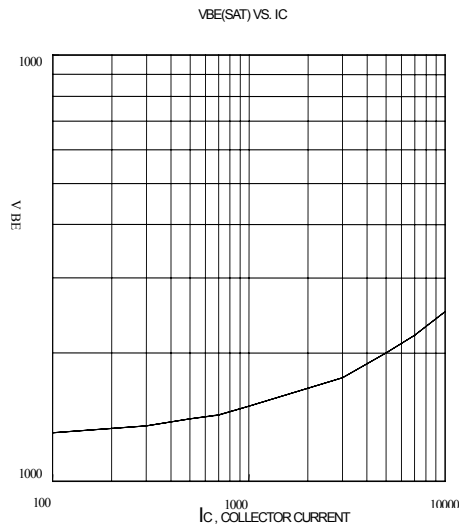
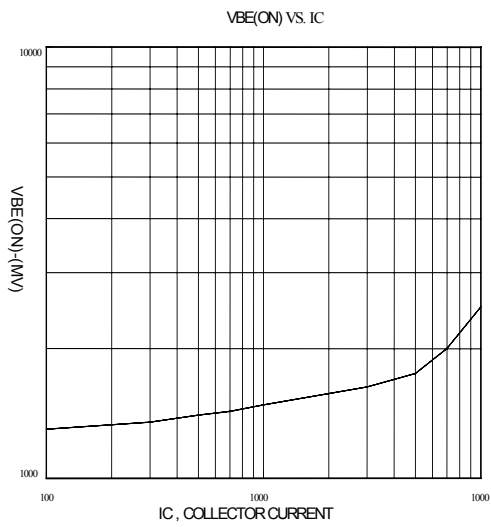
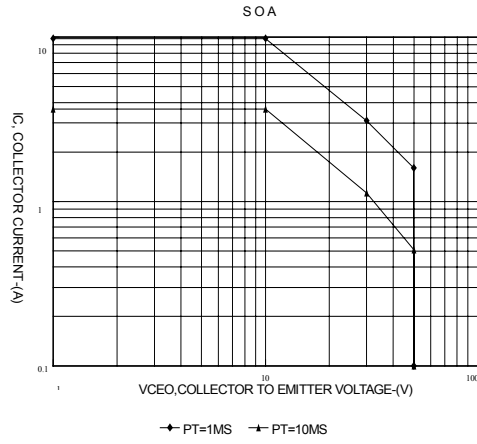
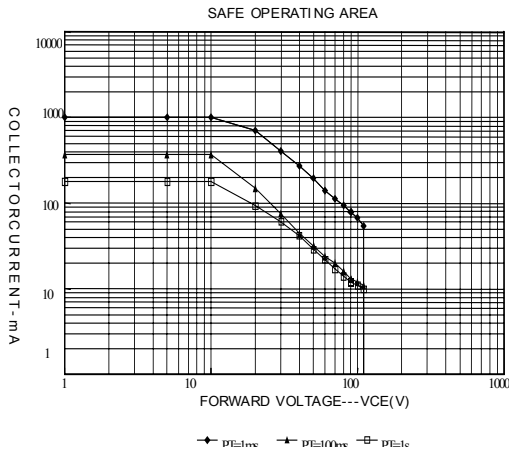

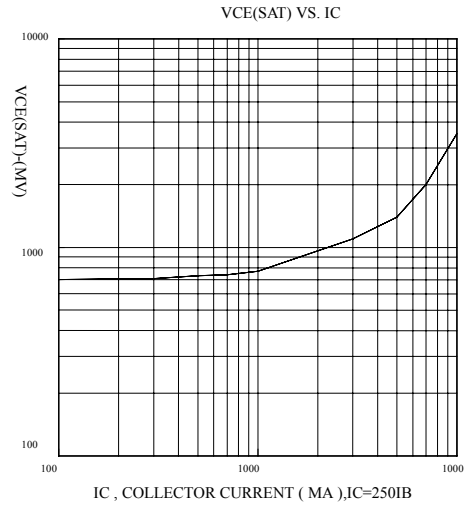
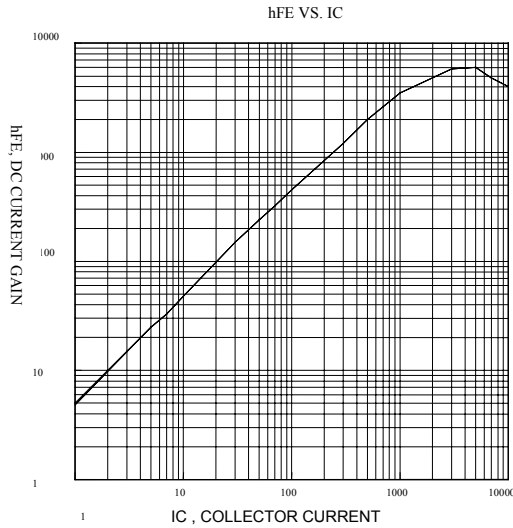

UTC assumes no responsibility for equipment failures that result from using products at values that exceed, even momentarily, rated values (such as maximum ratings, operating condition ranges, or other parameters) listed in products specifications of any and all UTC products described or contained herein. UTC products are not designed for use in life support appliances, devices or systems where malfunction of these products can be reasonably expected to result in personal injury. Reproduction in whole or in part is prohibited without the prior written consent of the copyright owner. The information presented in this document does not form part of any quotation or contract, is believed to be accurate and reliable and may be changed without notice.