

NJM4558/4559

The NJM4558/4559 integrated circuit are a dual high-gain operational amplifier internally compensated and constructed on a single silicon chip using an advanced epitaxial process.

Combining the features of the NJM741 with the close parameter matching and tracking of a dual device on a monolithic chip results in unique performance characteristics. Excellent channel separation allow the use of the dual device in single NJM741 operational amplifier applications providing density. It is especially well suited for applications in differential-in, differential-out as well as in potentiometric amplifiers and where gain and phase matched channels are mandatory.

Package Outline

Absolute Maximum Ratings (Ta=25°C)

| | | |
|-----------------------------|--------------------------------|------------|
| Supply Voltage | V ⁺ /V ⁻ | ±18V |
| Differential Input Voltage | V _{ID} | ±30V |
| Input Voltage (note) | V _I | ±15V |
| Power Dissipation | P _D (D-Type) | 500mW |
| | (M,E-Type) | 300mW |
| | (L-Type) | 800mW |
| Operating Temperature Range | T _{opr} | -20~+75°C |
| Storage Temperature Range | T _{stg} | -40~+125°C |

(note) For supply voltage less than ±15V, the absolute maximum input voltage is equal to the supply voltage.

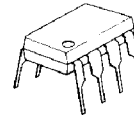

NJM4558D
NJM4559D

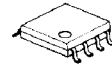

NJM4558M
NJM4559M



NJM4558E
NJM4559E

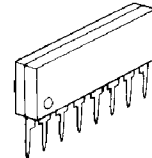

NJM4558L
NJM4559L

Electrical Characteristics (Ta=25°C, V⁺/V⁻=±15V)

| Parameter | Symbol | Test Condition | Min. | Typ. | Max. | Unit |
|---------------------------------|------------------|---|------|------|------|-------|
| Input Offset Voltage | V _{IO} | R _S ≤ 10kΩ | — | 0.5 | 6 | mV |
| Input Offset Current | I _{IO} | | — | 5 | 200 | nA |
| Input Bias Current | I _B | | — | 50 | 500 | nA |
| Input Resistance | R _{IN} | | 0.3 | 5 | — | MΩ |
| Large Signal Voltage Gain | A _V | R _L ≥ 2kΩ, V _O = ±10V | 86 | 100 | — | dB |
| Maximum Output Voltage Swing 1 | V _{OM1} | R _L ≥ 10kΩ | ±12 | ±14 | — | V |
| Maximum Output Voltage Swing 2 | V _{OM2} | R _L ≥ 2kΩ | ±10 | ±13 | — | V |
| Input Common Mode Voltage Range | V _{ICM} | | ±12 | ±14 | — | V |
| Common Mode Rejection Ratio | CMR | R _S ≤ 10kΩ | 70 | 90 | — | dB |
| Supply Voltage Rejection Ratio | SVR | R _S ≤ 10kΩ | 76.5 | 90 | — | dB |
| Supply Current | I _{CC} | | — | 3.5 | 5.7 | mA |
| Slew Rate | SR | | — | 1 | — | V/μs |
| NJM4558 | SR | | — | 2 | — | V/μs |
| NJM4559 | SR | | — | 2 | — | V/μs |
| Equivalent Input Noise Voltage | V _{NI} | RIAA, R _S = 1kΩ, 30kHz LPF | — | 1.4 | — | μVrms |

Connection Diagram

Equivalent Circuit (1/2 Shown)

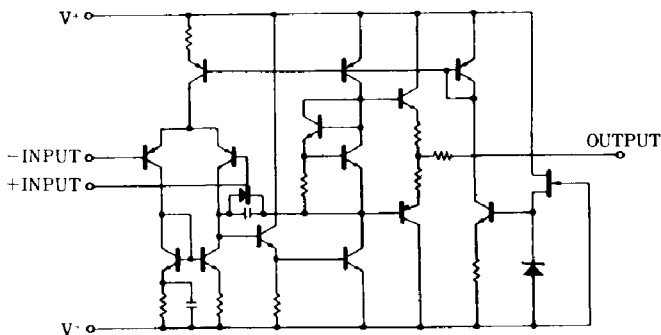

D,M,E-Type
(Top View)

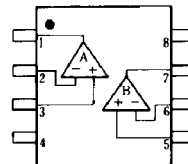

PIN FUNCTION

1. A OUTPUT
2. A- INPUT
3. A+ INPUT
4. V⁻
5. B+ INPUT
6. B- INPUT
7. B OUTPUT
8. V⁺

L-Type

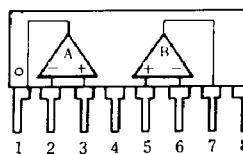

■ Typical Characteristics

Input Bias Current vs. Ambient

($V^+/V^- = \pm 15V$)

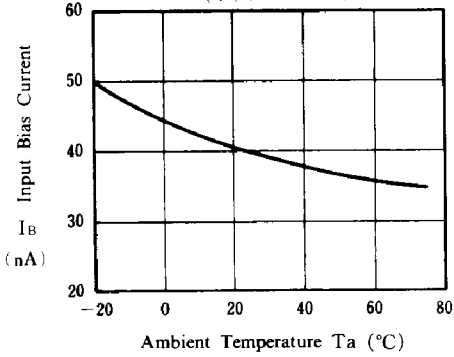

Maximum Output Voltage Swing vs. Load Resistance

($V^+/V^- = \pm 15V, T_a = 25^\circ C$)

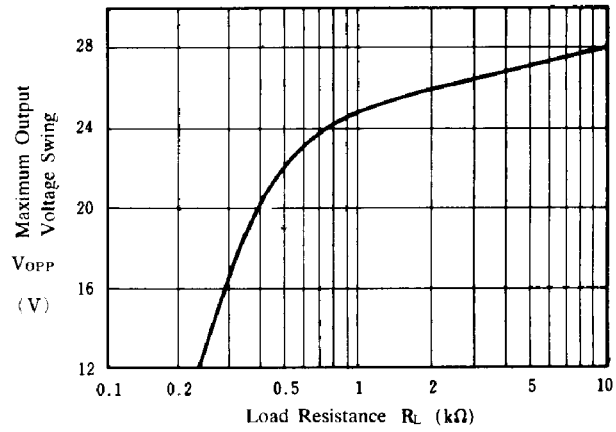

Maximum Output Voltage Swing vs. Supply Voltage

($R_L = 2k\Omega, T_a = 25^\circ C$)

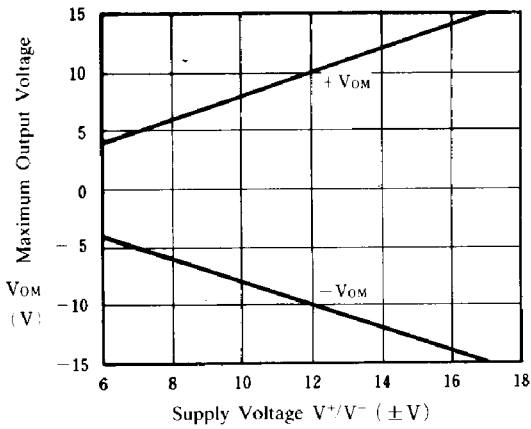

Equivalent Input Noise Voltage vs. Frequency

($V^+/V^- = \pm 15V, R_S = 50\Omega, A_v = 60dB, T_a = 25^\circ C$)

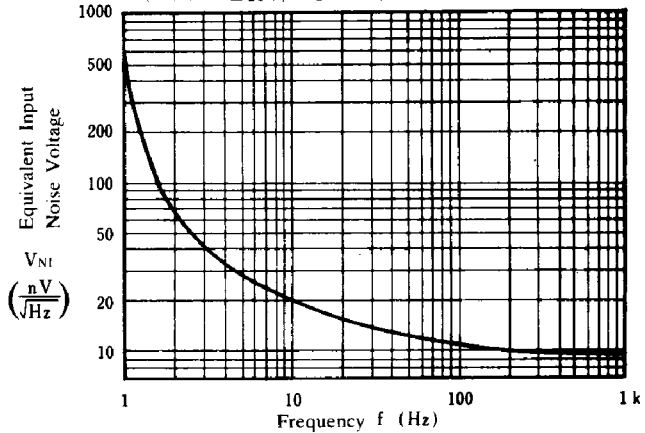

Open Loop Voltage Gain vs. Frequency

($V^+/V^- = \pm 15V, R_L = 2k\Omega, T_a = 25^\circ C$)

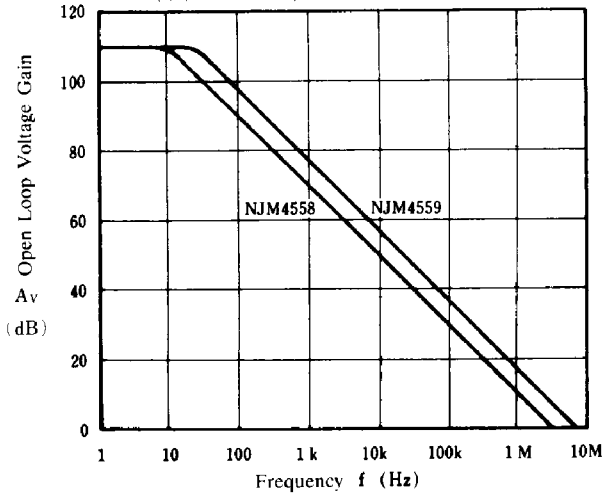

Maximum Output Voltage Swing vs. Frequency

($V^+/V^- = \pm 15V, R_L = 2k\Omega, T_a = 25^\circ C$)

