

THREE-TERMINAL POSITIVE VOLTAGE REGULATORS

These voltage regulators are monolithic integrated circuits designed as fixed-voltage regulators for a wide variety of applications including local, on-card regulation. These regulators employ internal current limiting, thermal shutdown, and safe-area

compensation. With adequate heatsinking they can deliver output currents in excess of 1.5 ampere.

Although designed primarily as a fixed voltage regulator, these devices can be used with external components to obtain adjustable voltages and currents.

FEATURES

- Output Current in Excess of 1.5 Ampere
- No External Components Required
- Internal Thermal Overload Protection
- Internal Short-Circuit Current Limiting
- Output Transistor Safe-Area Compensation
- Output Voltage Offered in 2% Tolerance

PIN ARRANGEMENT

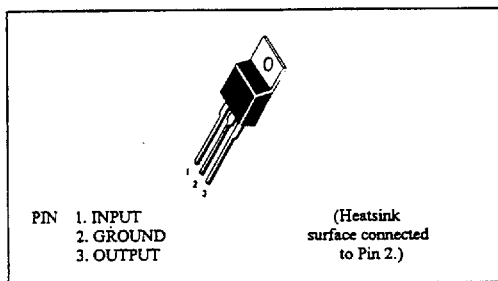

CIRCUIT SCHEMATIC

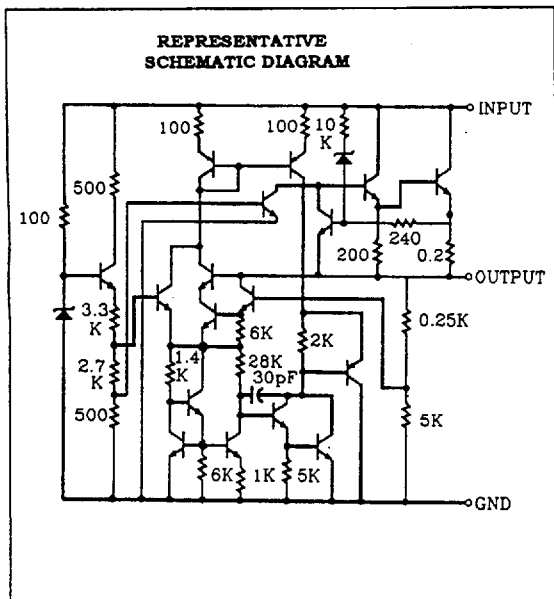

TYPICAL CONNECTING CIRCUIT

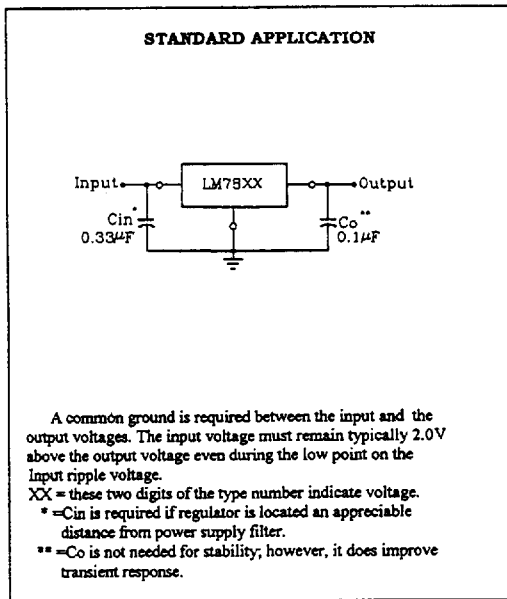

ABSOLUTE MAXIMUM RATINGS (Ta=25°C)

Item	Symbol	LM7800 Series	Unit
Input Voltage	Vin *	30	V
Input Voltage	Vin **	40	V
Power Dissipation	P _D ***	15	W
Operating Ambient Temperature	T _{opr}	-20 to +75	°C
Operating Junction Temperature	T _j	-20 to +125	°C
Storage Temperature	T _{stg}	-55 to +125	°C

Note: *LM7805 to LM7818

** LM7824

***Follow the derating curve

LM7805 ELECTRICAL CHARACTERISTICS

(Vin=10V, I_{out}=500mA, 0°C ≤ T_j ≤ 125°C, C_{in}=0.33μF, C_{out}=0.1μF; unless otherwise specified.)

Item	Symbol	Test Conditions	min.	typ.	max.	unit	
Output Voltage	V _{out}	T _j =25°C	4.90	5.0	5.10	V	
		7V ≤ V _{in} ≤ 20V, 5mA ≤ I _{out} ≤ 1.0A, P _D ≤ 15W	4.85	--	5.15	V	
Line Regulation	REG _{line}	T _j =25°C	7V ≤ V _{in} ≤ 25V	--	3	100	mV
			8V ≤ V _{in} ≤ 12V	--	1	50	mV
			5mA ≤ I _{out} ≤ 1.5A	--	15	100	mV
Load Regulation	REG _{load}	T _j =25°C	250mA ≤ I _{out} ≤ 750mA	--	5	50	mV
Quiescent Current	I _q	T _j =25°C, I _{out} =0	--	4.2	8.0	mA	
Quiescent Current Change	Δ I _q	7V ≤ V _{in} ≤ 25V	--	--	1.3	mA	
		5mA ≤ I _{out} ≤ 1.0A	--	--	0.5	mA	
Output Noise Voltage	V _n	T _a =25°C, 10Hz ≤ f ≤ 100KHz	--	40	--	μV	
Ripple Rejection Ratio	RR	f=120Hz	62	78	--	dB	
Voltage Drop	V _{drop}	I _{out} =1.0A, T _j =25°C	--	2.0	--	V	
Output Resistance	R _{out}	f=1KHz	--	17	--	mΩ	
Output Short Circuit Current	I _{os}	T _j =25°C	--	750	--	mA	
Peak Output Current	I _{o peak}	T _j =25°C	--	2.2	--	A	
Temperature Coefficient of Output Voltage	Δ V _{out} /Δ T _j	I _{out} =5mA, 0°C ≤ T _j ≤ 125°C	--	-1.1	--	mV/°C	

LM7806 ELECTRICAL CHARACTERISTICS

(Vin=11V, Iout=500mA, 0°C ≤ Tj ≤ 125°C, Cin=0.33μF, Cout=0.1μF; unless otherwise specified.)

Item	Symbol	Test Conditions	min.	typ.	max.	unit	
Output Voltage	Vout	Tj=25°C	5.88	6.0	6.12	V	
		8V ≤ Vin ≤ 21V, 5mA ≤ Iout ≤ 1.0A, PD ≤ 15W	5.83	--	6.17	V	
Line Regulation	Δ REGline	Tj=25°C	8V ≤ Vin ≤ 25V	--	5	120	mV
			9V ≤ Vin ≤ 13V	--	1.5	60	mV
Load Regulation	Δ REGload	Tj=25°C	5mA ≤ Iout ≤ 1.5A	--	14	120	mV
			250mA ≤ Iout ≤ 750mA	--	4.0	60	mV
Quiescent Current	Iq	Tj=25°C, Iout=0	--	4.3	8.0	mA	
Quiescent Current Change	Δ Iq	Tj=25°C	8V ≤ Vin ≤ 25V	--	--	1.3	mA
			5mA ≤ Iout ≤ 1.0A	--	--	0.5	mA
Output Noise Voltage	Vn	Ta=25°C, 10Hz ≤ f ≤ 100KHz	--	45	--	μV	
Ripple Rejection Ratio	RR	f=120Hz	59	75	--	dB	
Voltage Drop	Vdrop	Iout=1.0A, Tj=25°C	--	2.0	--	V	
Output Resistance	Rout	f=1KHz	--	19	--	mΩ	
Output Short Circuit Current	Ios	Tj=25°C	--	550	--	mA	
Peak Output Current	Io peak	Tj=25°C	--	2.2	--	A	
Temperature Coefficient of Output Voltage	Δ Vout/Δ Tj	Iout=5mA, 0°C ≤ Tj ≤ 125°C	--	-0.8	--	mV/°C	

LM7808 ELECTRICAL CHARACTERISTICS

(Vin=14V, Iout=500mA, 0°C ≤ Tj ≤ 125°C, Cin=0.33μF, Cout=0.1μF; unless otherwise specified.)

Item	Symbol	Test Conditions	min.	typ.	max.	unit	
Output Voltage	Vout	Tj=25°C	7.84	8.0	8.16	V	
		10.5V ≤ Vin ≤ 23V, 5mA ≤ Iout ≤ 1.0A, PD ≤ 15W	7.74	--	8.26	V	
Line Regulation	Δ REGline	Tj=25°C	10.5V ≤ Vin ≤ 25V	--	6	160	mV
			11V ≤ Vin ≤ 17V	--	2.0	80	mV
Load Regulation	Δ REGload	Tj=25°C	5mA ≤ Iout ≤ 1.5A	--	12	160	mV
			250mA ≤ Iout ≤ 750mA	--	4	80	mV
Quiescent Current	Iq	Tj=25°C, Iout=0	--	4.3	8.0	mA	
Quiescent Current Change	Δ Iq	Tj=25°C	10.5V ≤ Vin ≤ 25V	--	--	1.0	mA
			5mA ≤ Iout ≤ 1.0A	--	--	0.5	mA
Output Noise Voltage	Vn	Ta=25°C, 10Hz ≤ f ≤ 100KHz	--	52	--	μV	
Ripple Rejection Ratio	RR	f=120Hz	56	72	--	dB	
Voltage Drop	Vdrop	Iout=1.0A, Tj=25°C	--	2.0	--	V	
Output Resistance	Rout	f=1KHz	--	16	--	mΩ	
Output Short Circuit Current	Ios	Tj=25°C	--	450	--	mA	
Peak Output Current	Io peak	Tj=25°C	--	2.2	--	A	
Temperature Coefficient of Output Voltage	Δ Vout/Δ Tj	Iout=5mA, 0°C ≤ Tj ≤ 125°C	--	-1.8	--	mV/°C	

LM7809 ELECTRICAL CHARACTERISTICS

($V_{in}=15V$, $I_{out}=500mA$, $0^{\circ}C \leq T_j \leq 125^{\circ}C$, $C_{in}=0.33\mu F$, $C_{out}=0.1\mu F$; unless otherwise specified.)

Item	Symbol	Test Conditions	min.	typ.	max.	unit	
Output Voltage	Vout	$T_j=25^{\circ}C$	8.82	9	9.18	V	
		$10.5V \leq V_{in} \leq 27V$, $5mA \leq I_{out} \leq 1.0A$, $P_D \leq 15W$	8.77	--	9.23	V	
Line Regulation	Δ REGline	$T_j=25^{\circ}C$	$11.5V \leq V_{in} \leq 30V$	--	6	160	mV
			$12V \leq V_{in} \leq 18V$	--	2.0	80	mV
Load Regulation	Δ REGload	$T_j=25^{\circ}C$	$5mA \leq I_{out} \leq 1.5A$	--	12	160	mV
			$250mA \leq I_{out} \leq 750mA$	--	4	80	mV
Quiescent Current	Iq	$T_j=25^{\circ}C$, $I_{out}=0$	--	4.3	1.0	mA	
Quiescent Current Change	Δ Iq	$5mA \leq I_{out} \leq 1.0A$	$14.5V \leq V_{in} \leq 30V$	--	--	0.5	mA
				--	--	--	mA
Output Noise Voltage	Vn	$T_a=25^{\circ}C$, $10Hz \leq f_s \leq 100KHz$	--	52	--	μV	
Ripple Rejection Ratio	RR	$f=120Hz$	55	72	--	dB	
Voltage Drop	Vdrop	$I_{out}=1.0A$, $T_j=25^{\circ}C$	--	2.0	--	V	
Output Resistance	Rout	$f=1KHz$	--	16	--	m Ω	
Output Short Circuit Current	Ios	$T_j=25^{\circ}C$	--	450	--	mA	
Peak Output Current	I _{o peak}	$T_j=25^{\circ}C$	--	2.2	--	A	
Temperature Coefficient of Output Voltage	$\Delta V_{out}/\Delta T_j$	$I_{out}=5mA$, $0^{\circ}C \leq T_j \leq 125^{\circ}C$	--	-1.8	--	mV/ $^{\circ}C$	

LM7810 ELECTRICAL CHARACTERISTICS

($V_{in}=16V$, $I_{out}=500mA$, $0^{\circ}C \leq T_j \leq 125^{\circ}C$, $C_{in}=0.33\mu F$, $C_{out}=0.1\mu F$; unless otherwise specified.)

Item	Symbol	Test Conditions	min.	typ.	max.	unit	
Output Voltage	Vout	$T_j=25^{\circ}C$	9.8	10	10.2	V	
		$17.5V \leq V_{in} \leq 30V$, $5mA \leq I_{out} \leq 1.0A$, $P_D \leq 15W$	9.75	-	12.25	V	
Line Regulation	Δ REGline	$T_j=25^{\circ}C$	$10.5V \leq V_{in} \leq 30V$	--	10	240	mV
			$13V \leq V_{in} \leq 9V$	--	3.0	120	mV
Load Regulation	Δ REGload	$T_j=25^{\circ}C$	$5mA \leq I_{out} \leq 1.5A$	--	12	240	mV
			$250mA \leq I_{out} \leq 750mA$	--	4.0	120	mV
Quiescent Current	Iq	$T_j=25^{\circ}C$, $I_{out}=0$	--	4.3	8.0	mA	
Quiescent Current Change	Δ Iq	$5mA \leq I_{out} \leq 1.0A$	$14.5V \leq V_{in} \leq 30V$	--	--	1.0	mA
				--	--	0.5	mA
Output Noise Voltage	Vn	$T_a=25^{\circ}C$, $10Hz \leq f_s \leq 100KHz$	--	52	--	μV	
Ripple Rejection Ratio	RR	$f=120Hz$	54	72	--	dB	
Voltage Drop	Vdrop	$I_{out}=1.0A$, $T_j=25^{\circ}C$	--	2.0	--	V	
Output Resistance	Rout	$f=1KHz$	--	16	--	m Ω	
Output Short Circuit Current	Ios	$T_j=25^{\circ}C$	--	450	--	mA	
Peak Output Current	I _{o peak}	$T_j=25^{\circ}C$	--	2.2	--	A	
Temperature Coefficient of Output Voltage	$\Delta V_{out}/\Delta T_j$	$I_{out}=5mA$, $0^{\circ}C \leq T_j \leq 125^{\circ}C$	--	-1.8	--	mV/ $^{\circ}C$	

• LM7812 ELECTRICAL CHARACTERISTICS

($V_{in}=19V$, $I_{out}=500mA$, $0^{\circ}C \leq T_j \leq 125^{\circ}C$, $C_{in}=0.33\mu F$, $C_{out}=0.1\mu F$; unless otherwise specified.)

Item	Symbol	Test Conditions	min.	typ.	max.	unit	
Output Voltage	Vout	$T_j=25^{\circ}C$	11.76	12.0	12.24	V	
		$14.5V \leq V_{in} \leq 27V$, $5mA \leq I_{out} \leq 1.0A$, $P_D \leq 15W$	11.66	--	12.34	V	
Line Regulation	Δ REGline	$T_j=25^{\circ}C$	$14.5V \leq V_{in} \leq 30V$	--	10	240	mV
			$16V \leq V_{in} \leq 22V$	--	3.0	120	mV
Load Regulation	Δ REGload	$T_j=25^{\circ}C$	$5mA \leq I_{out} \leq 1.5A$	--	12	240	mV
			$250mA \leq I_{out} \leq 750mA$	--	4.0	120	mV
Quiescent Current	Iq	$T_j=25^{\circ}C$, $I_{out}=0$	--	4.3	8.0	mA	
Quiescent Current Change	Δ Iq	$14.5V \leq V_{in} \leq 30V$ $5mA \leq I_{out} \leq 1.0A$	--	--	1.0	mA	
			--	--	0.5	mA	
Output Noise Voltage	Vn	$T_a=25^{\circ}C$, $10Hz \leq f \leq 100KHz$	--	75	--	μ V	
Ripple Rejection Ratio	RR	$f=120Hz$	55	71	--	dB	
Voltage Drop	Vdrop	$I_{out}=1.0A$, $T_j=25^{\circ}C$	--	2.0	--	V	
Output Resistance	Rout	$f=1KHz$	--	18	--	m Ω	
Output Short Circuit Current	Ios	$T_j=25^{\circ}C$	--	350	--	mA	
Peak Output Current	I _{o peak}	$T_j=25^{\circ}C$	--	2.2	--	A	
Temperature Coefficient of Output Voltage	Δ Vout/ Δ Tj	$I_{out}=5mA$, $0^{\circ}C \leq T_j \leq 125^{\circ}C$	--	-1.0	--	mV/ $^{\circ}C$	

• LM7815 ELECTRICAL CHARACTERISTICS

($V_{in}=23V$, $I_{out}=500mA$, $0^{\circ}C \leq T_j \leq 125^{\circ}C$, $C_{in}=0.33\mu F$, $C_{out}=0.1\mu F$; unless otherwise specified.)

Item	Symbol	Test Conditions	min.	typ.	max.	unit	
Output Voltage	Vout	$T_j=25^{\circ}C$	14.7	15.0	15.3	V	
		$17.5V \leq V_{in} \leq 30V$, $5mA \leq I_{out} \leq 1.0A$, $P_D \leq 15W$	14.55	--	15.45	V	
Line Regulation	Δ REGline	$T_j=25^{\circ}C$	$17.5V \leq V_{in} \leq 30V$	--	11	300	mV
			$20V \leq V_{in} \leq 26V$	--	3.0	150	mV
Load Regulation	Δ REGload	$T_j=25^{\circ}C$	$5mA \leq I_{out} \leq 1.5A$	--	12	300	mV
			$250mA \leq I_{out} \leq 750mA$	--	4	150	mV
Quiescent Current	Iq	$T_j=25^{\circ}C$, $I_{out}=0$	--	4.4	8.0	mA	
Quiescent Current Change	Δ Iq	$17.5V \leq V_{in} \leq 30V$ $5mA \leq I_{out} \leq 1.0A$	--	--	1.0	mA	
			--	--	0.5	mA	
Output Noise Voltage	Vn	$T_a=25^{\circ}C$, $10Hz \leq f \leq 100KHz$	--	90	--	μ V	
Ripple Rejection Ratio	RR	$f=120Hz$	54	70	--	dB	
Voltage Drop	Vdrop	$I_{out}=1.0A$, $T_j=25^{\circ}C$	--	2.0	--	V	
Output Resistance	Rout	$f=1KHz$	--	19	--	m Ω	
Output Short Circuit Current	Ios	$T_j=25^{\circ}C$	--	230	--	mA	
Peak Output Current	I _{o peak}	$T_j=25^{\circ}C$	--	2.1	--	A	
Temperature Coefficient of Output Voltage	Δ Vout/ Δ Tj	$I_{out}=5mA$, $0^{\circ}C \leq T_j \leq 125^{\circ}C$	--	-1.0	--	mV/ $^{\circ}C$	

LM7818 ELECTRICAL CHARACTERISTICS

($V_{in}=27V$, $I_{out}=500mA$, $0^{\circ}C \leq T_j \leq 125^{\circ}C$, $C_{in}=0.33\mu F$, $C_{out}=0.1\mu F$; unless otherwise specified.)

Item	Symbol	Test Conditions	min.	typ.	max.	unit	
Output Voltage	Vout	Tj=25°C	17.64	18.0	18.36	V	
		21.0V ≤ Vin ≤ 33V, 5mA ≤ Iout ≤ 1.0A, Pd ≤ 15W	17.44	--	18.56	V	
Line Regulation	Δ Vo line	Tj=25°C	21.0V ≤ Vin ≤ 33V	--	15	360	mV
			24V ≤ Vin ≤ 30V	--	5.0	180	mV
Load Regulation	Δ REGload	Tj=25°C	5mA ≤ Iout ≤ 1.5A	--	12	360	mV
			250mA ≤ Iout ≤ 750mA	--	4.0	180	mV
Quiescent Current	Iq	Tj=25°C, Iout=0		--	4.5	8.0	mA
			21.0V ≤ Vin ≤ 33V	--	--	1.0	mA
Quiescent Current Change	Δ Iq	5mA ≤ Iout ≤ 1.0A	--	--	0.5	mA	
Output Noise Voltage	Vn	Ta=25°C, 10Hz ≤ f ≤ 100KHz	--	110	--	μ V	
Ripple Rejection Ratio	RR	f=120Hz	53	69	--	dB	
Voltage Drop	Vdrop	Iout=1.0A, Tj=25°C	--	2.0	--	V	
Output Resistance	Rout	f=1KHz	--	22	--	mΩ	
Output Short Circuit Current	Ios	Tj=25°C	--	200	--	mA	
Peak Output Current	Io peak	Tj=25°C	--	2.1	--	A	
Temperature Coefficient of Output Voltage	Δ Vout/ Δ Tj	Iout=5mA, 0°C ≤ Tj ≤ 125°C	--	-1.0	--	mV/°C	

LM7824 ELECTRICAL CHARACTERISTICS

($V_{in}=33V$, $I_{out}=500mA$, $0^{\circ}C \leq T_j \leq 125^{\circ}C$, $C_{in}=0.33\mu F$, $C_{out}=0.1\mu F$; unless otherwise specified.)

Item	Symbol	Test Conditions	min.	typ.	max.	unit	
Output Voltage	Vout	Tj=25°C	23.52	24.0	24.48	V	
		27.0V ≤ Vin ≤ 38V, 5mA ≤ Iout ≤ 1.0A, Pd ≤ 15W	23.32	--	24.68	V	
Line Regulation	Δ Vo line	Tj=25°C	27.0V ≤ Vin ≤ 38V	--	18	480	mV
			30V ≤ Vin ≤ 36V	--	6.0	240	mV
Load Regulation	Δ Vo load	Tj=25°C	5mA ≤ Iout ≤ 1.5A	--	12	480	mV
			250mA ≤ Iout ≤ 750mA	--	4.0	240	mV
Quiescent Current	Iq	Tj=25°C, Iout=0		--	4.6	8.0	mA
			27.0V ≤ Vin ≤ 38V	--	--	1.0	mA
Quiescent Current Change	Δ Iq	5mA ≤ Iout ≤ 1.0A	--	--	0.5	mA	
Output Noise Voltage	Vn	Ta=25°C, 10Hz ≤ f ≤ 100KHz	--	170	--	μ V	
Ripple Rejection Ratio	RR	f=120Hz	50	66	--	dB	
Voltage Drop	Vdrop	Iout=1.0A, Tj=25°C	--	2.0	--	V	
Output Resistance	Rout	f=1KHz	--	28	--	mΩ	
Output Short Circuit Current	Ios	Tj=25°C	--	150	--	mA	
Peak Output Current	Io peak	Tj=25°C	--	2.1	--	A	
Temperature Coefficient of Output Voltage	Δ Vout/ Δ Tj	Iout=5mA, 0°C ≤ Tj ≤ 125°C	--	-1.5	--	mV/°C	

FIGURE 1 - WORST CASE POWER DISSIPATION versus AMBIENT TEMPERATURE (Case 221A)

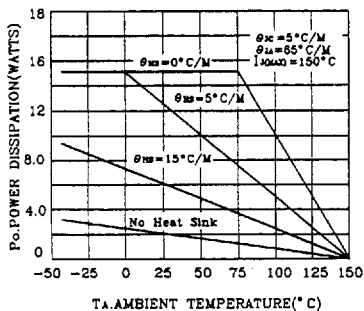

FIGURE 2 - WORST CASE POWER DISSIPATION versus AMBIENT TEMPERATURE (Case 1)

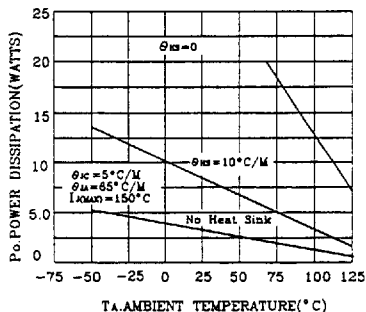

FIGURE 3 - INPUT OUTPUT DIFFERENTIAL AS A FUNCTION OF JUNCTION TEMPERATURE

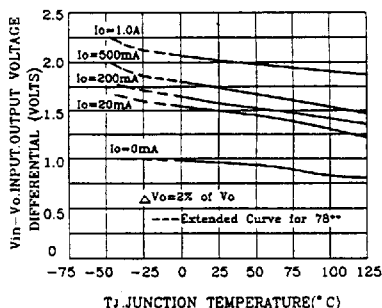

FIGURE 4 - INPUT OUTPUT DIFFERENTIAL AS A FUNCTION OF JUNCTION TEMPERATURE

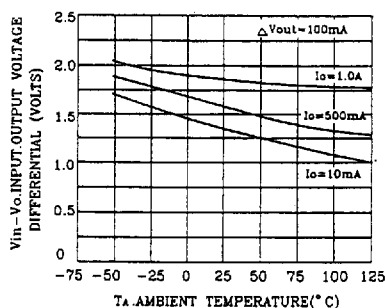

FIGURE 5 - PEAK OUTPUT CURRENT AS A FUNCTION OF INPUT-OUTPUT DIFFERENTIAL VOLTAGE

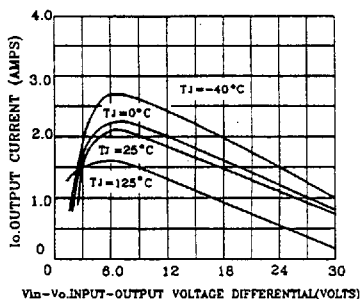

FIGURE 6 - PEAK OUTPUT CURRENT AS A FUNCTION OF INPUT-OUTPUT DIFFERENTIAL VOLTAGE

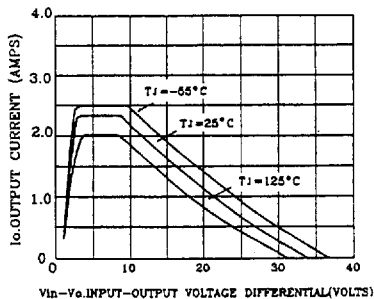

FIGURE 7 - RIPPLE REJECTION AS A FUNCTION OF OUTPUT VOLTAGE

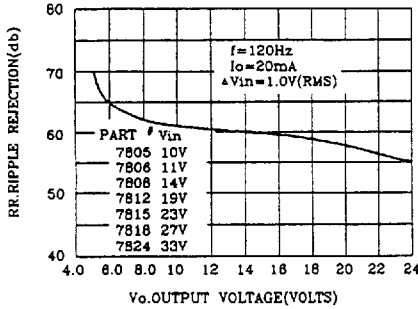

FIGURE 8 - RIPPLE REJECTION AS A FUNCTION OF FREQUENCY

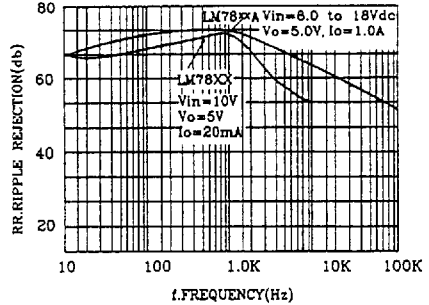

FIGURE 9 - OUTPUT VOLTAGE AS A FUNCTION OF JUNCTION TEMPERATURE

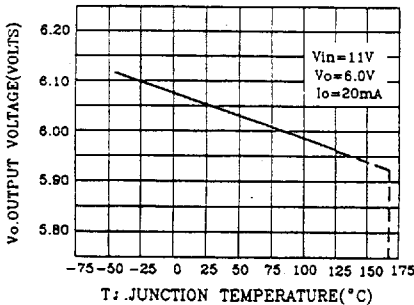

FIGURE 10 - OUTPUT IMPEDANCE AS A FUNCTION OF OUTPUT VOLTAGE

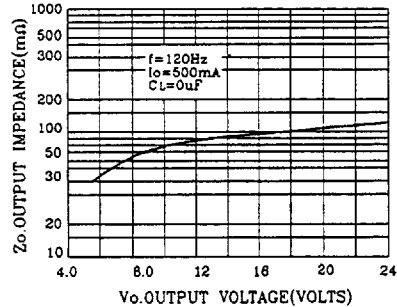

FIGURE 11 - QUIESCENT CURRENT AS A FUNCTION OF TEMPERATURE

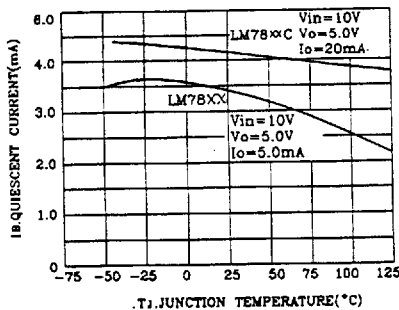

FIGURE 12 - DROPOUT CHARACTERISTICS

