

**MJE13005\***

\*Motorola Preferred Device

**4 AMPERE  
NPN SILICON  
POWER TRANSISTOR  
400 VOLTS  
75 WATTS**

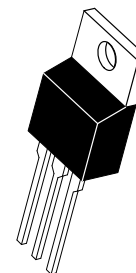

**CASE 221A-06  
TO-220AB**

*Designer's™ Data Sheet*  
**SWITCHMODE Series**  
**NPN Silicon Power Transistors**

These devices are designed for high-voltage, high-speed power switching inductive circuits where fall time is critical. They are particularly suited for 115 and 220 V SWITCHMODE applications such as Switching Regulator's, Inverters, Motor Controls, Solenoid/Relay drivers and Deflection circuits.

**SPECIFICATION FEATURES:**

- $V_{CEO(sus)}$  400 V
- Reverse Bias SOA with Inductive Loads @  $T_C = 100^\circ\text{C}$
- Inductive Switching Matrix 2 to 4 Amp, 25 and  $100^\circ\text{C}$   
...  $t_C @ 3A, 100^\circ\text{C}$  is 180 ns (Typ)
- 700 V Blocking Capability
- SOA and Switching Applications Information.

**MAXIMUM RATINGS**

Rating	Symbol	Value	Unit
Collector-Emitter Voltage	$V_{CEO(sus)}$	400	Vdc
Collector-Emitter Voltage	$V_{CEV}$	700	Vdc
Emitter Base Voltage	$V_{EBO}$	9	Vdc
Collector Current — Continuous — Peak (1)	$I_C$ $I_{CM}$	4 8	Adc
Base Current — Continuous — Peak (1)	$I_B$ $I_{BM}$	2 4	Adc
Emitter Current — Continuous — Peak (1)	$I_E$ $I_{EM}$	6 12	Adc
Total Power Dissipation @ $T_A = 25^\circ\text{C}$ Derate above $25^\circ\text{C}$	$P_D$	2 16	Watts mW/ $^\circ\text{C}$
Total Power Dissipation @ $T_C = 25^\circ\text{C}$ Derate above $25^\circ\text{C}$	$P_D$	75 600	Watts mW/ $^\circ\text{C}$
Operating and Storage Junction Temperature Range	$T_J, T_{stg}$	-65 to +150	$^\circ\text{C}$

**THERMAL CHARACTERISTICS**

Characteristic	Symbol	Max	Unit
Thermal Resistance, Junction to Ambient	$R_{\theta JA}$	62.5	$^\circ\text{C/W}$
Thermal Resistance, Junction to Case	$R_{\theta JC}$	1.67	$^\circ\text{C/W}$
Maximum Lead Temperature for Soldering Purposes: 1/8" from Case for 5 Seconds	$T_L$	275	$^\circ\text{C}$

(1) Pulse Test: Pulse Width = 5 ms, Duty Cycle  $\leq 10\%$ .

**Designer's Data for "Worst Case" Conditions** — The Designer's Data Sheet permits the design of most circuits entirely from the information presented. SOA Limit curves — representing boundaries on device characteristics — are given to facilitate "worst case" design.

**Preferred** devices are Motorola recommended choices for future use and best overall value.

Designer's and SWITCHMODE are trademarks of Motorola, Inc.

**REV 3**

# MJE13005

## ELECTRICAL CHARACTERISTICS (T<sub>C</sub> = 25°C unless otherwise noted)

Characteristic	Symbol	Min	Typ	Max	Unit
----------------	--------	-----	-----	-----	------

### \*OFF CHARACTERISTICS

Collector–Emitter Sustaining Voltage (I <sub>C</sub> = 10 mA, I <sub>B</sub> = 0)	V <sub>CEO(sus)</sub>	400	—	—	Vdc
Collector Cutoff Current (V <sub>CEV</sub> = Rated Value, V <sub>BE(off)</sub> = 1.5 Vdc) (V <sub>CEV</sub> = Rated Value, V <sub>BE(off)</sub> = 1.5 Vdc, T <sub>C</sub> = 100°C)	I <sub>CEV</sub>	—	—	1 5	mAdc
Emitter Cutoff Current (V <sub>EB</sub> = 9 Vdc, I <sub>C</sub> = 0)	I <sub>EBO</sub>	—	—	1	mAdc

### SECOND BREAKDOWN

Second Breakdown Collector Current with base forward biased	I <sub>S/b</sub>				See Figure 11
Clamped Inductive SOA with Base Reverse Biased	RBSOA				See Figure 12

### \*ON CHARACTERISTICS

DC Current Gain (I <sub>C</sub> = 1 Adc, V <sub>CE</sub> = 5 Vdc) (I <sub>C</sub> = 2 Adc, V <sub>CE</sub> = 5 Vdc)	h <sub>FE</sub>	10 8	— —	60 40	—
Collector–Emitter Saturation Voltage (I <sub>C</sub> = 1 Adc, I <sub>B</sub> = 0.2 Adc) (I <sub>C</sub> = 2 Adc, I <sub>B</sub> = 0.5 Adc) (I <sub>C</sub> = 4 Adc, I <sub>B</sub> = 1 Adc) (I <sub>C</sub> = 2 Adc, I <sub>B</sub> = 0.5 Adc, T <sub>C</sub> = 100°C)	V <sub>CE(sat)</sub>	— — — —	— — — —	0.5 0.6 1 1	Vdc
Base–Emitter Saturation Voltage (I <sub>C</sub> = 1 Adc, I <sub>B</sub> = 0.2 Adc) (I <sub>C</sub> = 2 Adc, I <sub>B</sub> = 0.5 Adc) (I <sub>C</sub> = 2 Adc, I <sub>B</sub> = 0.5 Adc, T <sub>C</sub> = 100°C)	V <sub>BE(sat)</sub>	— — —	— — —	1.2 1.6 1.5	Vdc

### DYNAMIC CHARACTERISTICS

Current–Gain — Bandwidth Product (I <sub>C</sub> = 500 mAdc, V <sub>CE</sub> = 10 Vdc, f = 1 MHz)	f <sub>T</sub>	4	—	—	MHz
Output Capacitance (V <sub>CB</sub> = 10 Vdc, I <sub>E</sub> = 0, f = 0.1 MHz)	C <sub>ob</sub>	—	65	—	pF

### SWITCHING CHARACTERISTICS

Resistive Load (Table 2)						
Delay Time	(V <sub>CC</sub> = 125 Vdc, I <sub>C</sub> = 2 A, I <sub>B1</sub> = I <sub>B2</sub> = 0.4 A, t <sub>p</sub> = 25 μs, Duty Cycle ≤ 1%)	t <sub>d</sub>	—	0.025	0.1	μs
Rise Time		t <sub>r</sub>	—	0.3	0.7	μs
Storage Time		t <sub>s</sub>	—	1.7	4	μs
Fall Time		t <sub>f</sub>	—	0.4	0.9	μs
Inductive Load, Clamped (Table 2, Figure 13)						
Voltage Storage Time	(I <sub>C</sub> = 2 A, V <sub>clamp</sub> = 300 Vdc, I <sub>B1</sub> = 0.4 A, V <sub>BE(off)</sub> = 5 Vdc, T <sub>C</sub> = 100°C)	t <sub>sv</sub>	—	0.9	4	μs
Crossover Time		t <sub>c</sub>	—	0.32	0.9	μs
Fall Time		t <sub>fi</sub>	—	0.16	—	μs

\*Pulse Test: Pulse Width = 300 μs, Duty Cycle = 2%.

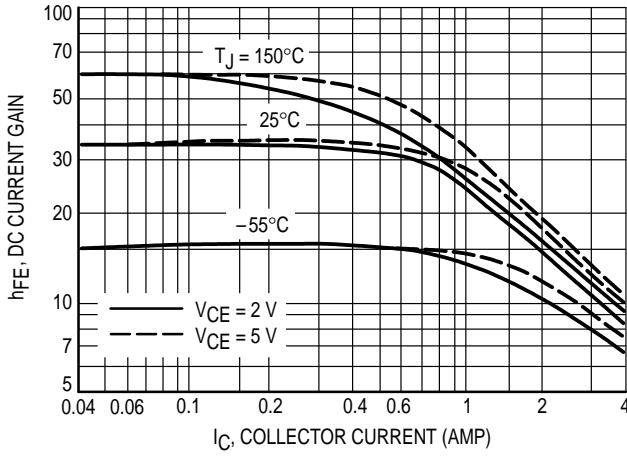

Figure 1. DC Current Gain

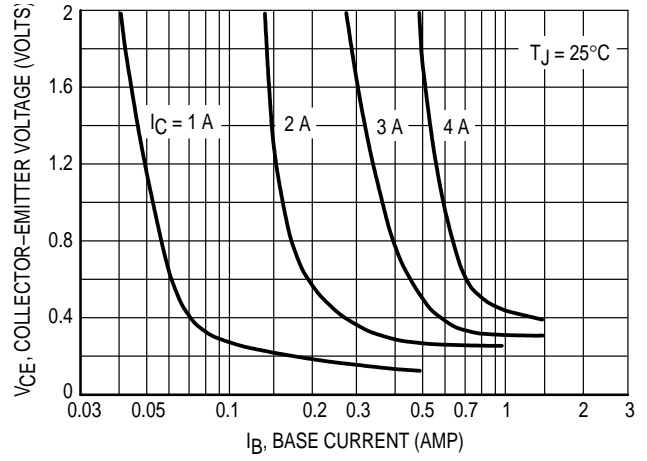

Figure 2. Collector Saturation Region

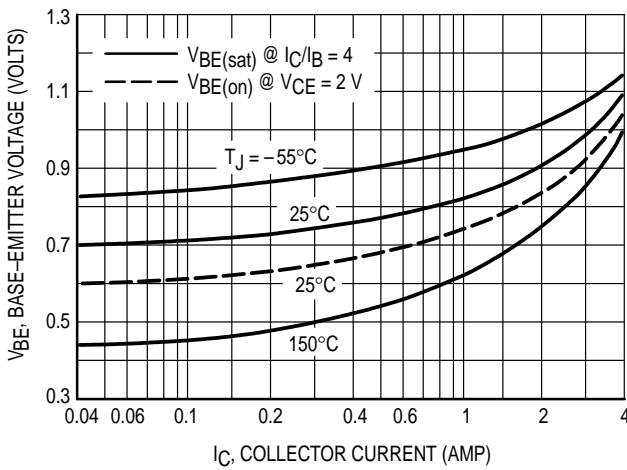

Figure 3. Base-Emitter Voltage

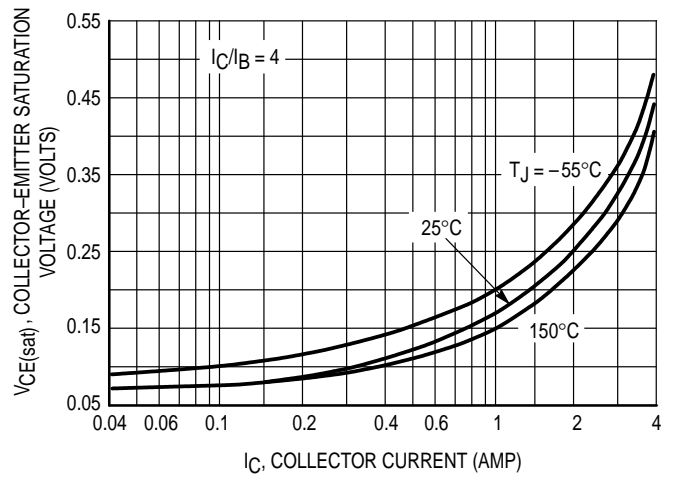

Figure 4. Collector-Emitter Saturation Voltage

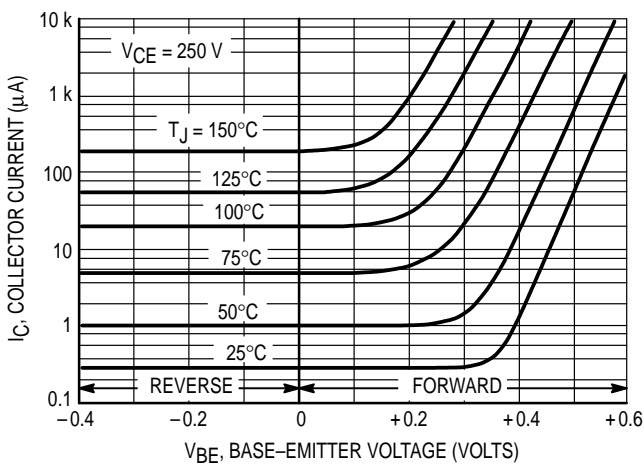

Figure 5. Collector Cutoff Region

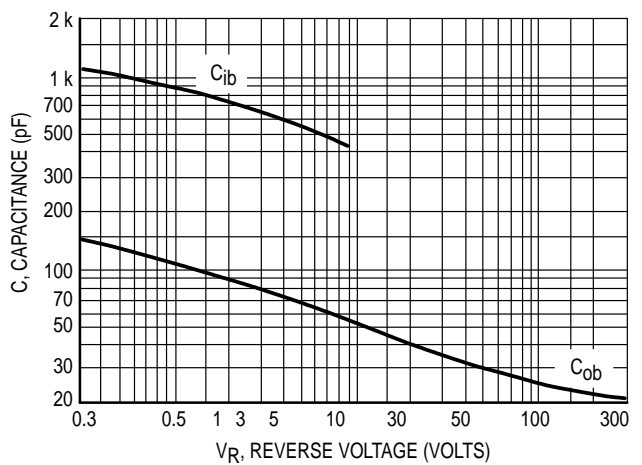

Figure 6. Capacitance

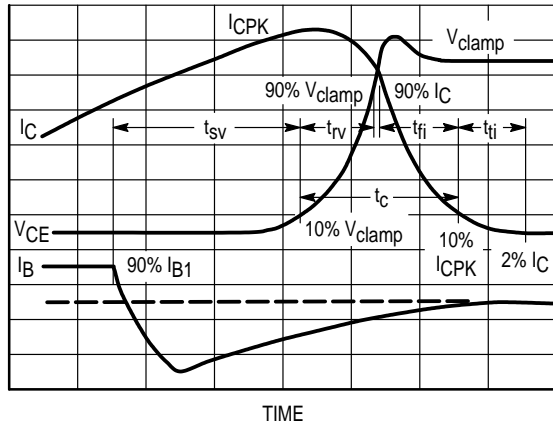

Figure 7. Inductive Switching Measurements

Table 1. Typical Inductive Switching Performance

IC AMP	TC °C	tsv ns	trv ns	tfi ns	tji ns	tc ns
2	25	600	70	100	80	180
	100	900	110	240	130	320
3	25	650	60	140	60	200
	100	950	100	330	100	350
4	25	550	70	160	100	220
	100	850	110	350	160	390

NOTE: All Data recorded in the inductive Switching Circuit In Table 2.

SWITCHING TIMES NOTE

In resistive switching circuits, rise, fall, and storage times have been defined and apply to both current and voltage waveforms since they are in phase. However, for inductive loads which are common to SWITCHMODE power supplies and hammer drivers, current and voltage waveforms are not in phase. Therefore, separate measurements must be made on each waveform to determine the total switching time. For this reason, the following new terms have been defined.

- tsv = Voltage Storage Time, 90% IB1 to 10% Vclamp
- trv = Voltage Rise Time, 10–90% Vclamp
- tfi = Current Fall Time, 90–10% IC
- tji = Current Tail, 10–2% IC
- tc = Crossover Time, 10% Vclamp to 10% IC

An enlarged portion of the inductive switching waveforms is shown in Figure 7 to aid in the visual identity of these terms.

For the designer, there is minimal switching loss during storage time and the predominant switching power losses occur during the crossover interval and can be obtained using the standard equation from AN-222:

$$PSWT = 1/2 V_{CC} I_C (t_c) f$$

In general,  $t_{rv} + t_{fi} \approx t_c$ . However, at lower test currents this relationship may not be valid.

As is common with most switching transistors, resistive switching is specified at 25°C and has become a benchmark for designers. However, for designers of high frequency converter circuits, the user oriented specifications which make this a "SWITCHMODE" transistor are the inductive switching speeds ( $t_c$  and  $t_{sv}$ ) which are guaranteed at 100°C.

RESISTIVE SWITCHING PERFORMANCE

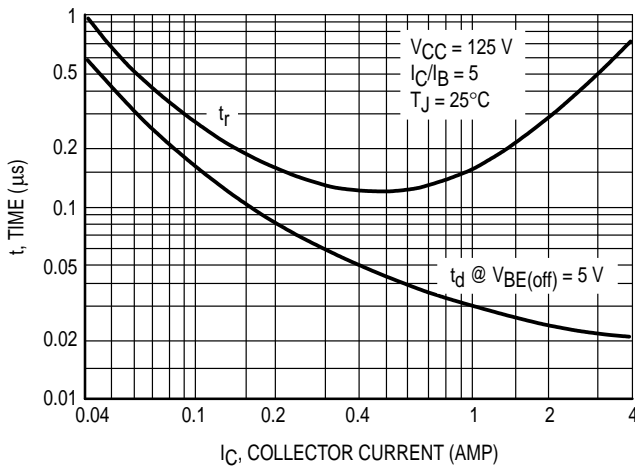

Figure 8. Turn-On Time

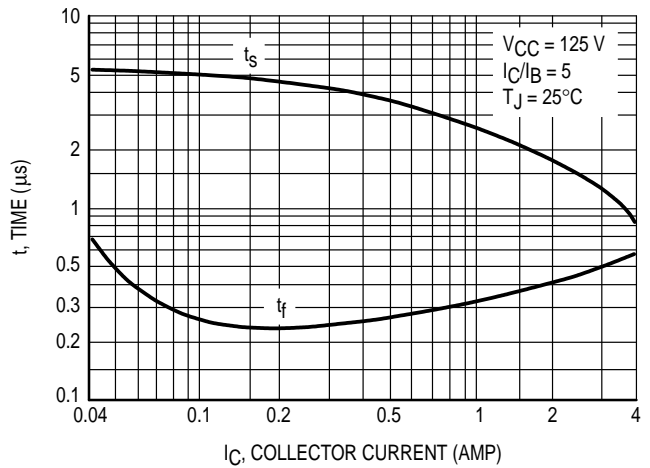

Figure 9. Turn-Off Time

Table 2. Test Conditions for Dynamic Performance

REVERSE BIAS SAFE OPERATING AREA AND INDUCTIVE SWITCHING		RESISTIVE SWITCHING
<b>TEST CIRCUITS</b>	<p>DUTY CYCLE <math>\leq 10\%</math> <math>t_r, t_f \leq 10</math> ns</p> <p><b>NOTE</b> PW and <math>V_{CC}</math> Adjusted for Desired <math>I_C</math> <math>R_B</math> Adjusted for Desired <math>I_{B1}</math></p>	
<b>CIRCUIT VALUES</b>	<p>Coil Data: Ferroxcube Core #6656 Full Bobbin (~16 Turns) #16</p> <p>GAP for 200 <math>\mu</math>H/20 A <math>L_{coil} = 200 \mu</math>H</p> <p><math>V_{CC} = 20</math> V <math>V_{clamp} = 300</math> Vdc</p>	<p><math>V_{CC} = 125</math> V <math>R_C = 62 \Omega</math> D1 = 1N5820 or Equiv. <math>R_B = 22 \Omega</math></p>
<b>TEST WAVEFORMS</b>	<p style="text-align: center;"><b>OUTPUT WAVEFORMS</b></p> <p><math>t_1</math> ADJUSTED TO OBTAIN <math>I_C</math> <math>t_1 \approx \frac{L_{coil} (I_{Cpk})}{V_{CC}}</math></p> <p><math>t_2 \approx \frac{L_{coil} (I_{Cpk})}{V_{clamp}}</math></p> <p>Test Equipment Scope—Tektronics 475 or Equivalent</p>	<p><math>t_r, t_f &lt; 10</math> ns Duty Cycle = 1.0% <math>R_B</math> and <math>R_C</math> adjusted for desired <math>I_B</math> and <math>I_C</math></p>

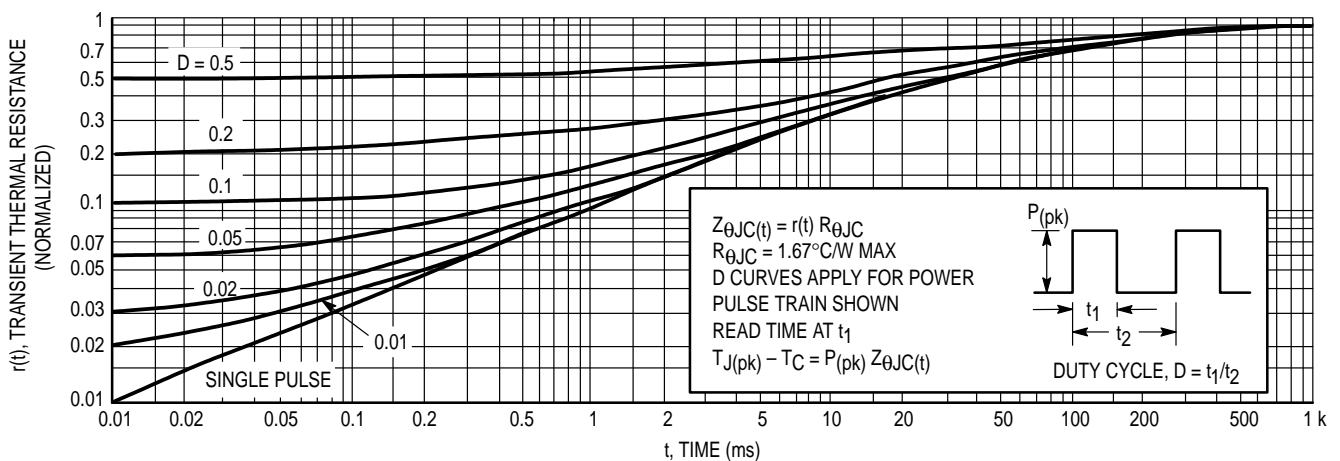

Figure 10. Typical Thermal Response [ $Z_{\theta JC}(t)$ ]

# MJE13005

The Safe Operating Area Figures 11 and 12 are specified ratings for these devices under the test conditions shown.

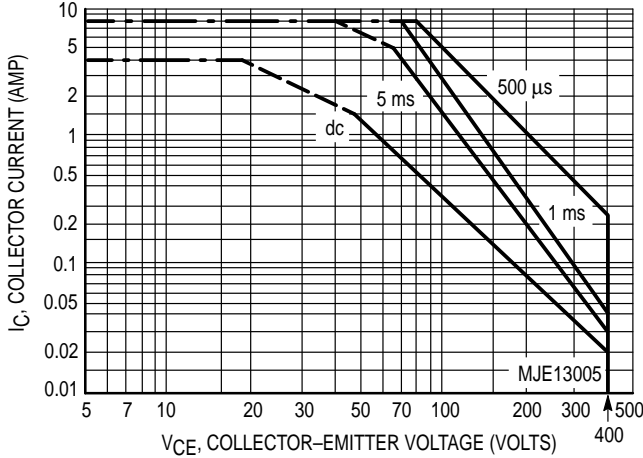

Figure 11. Forward Bias Safe Operating Area

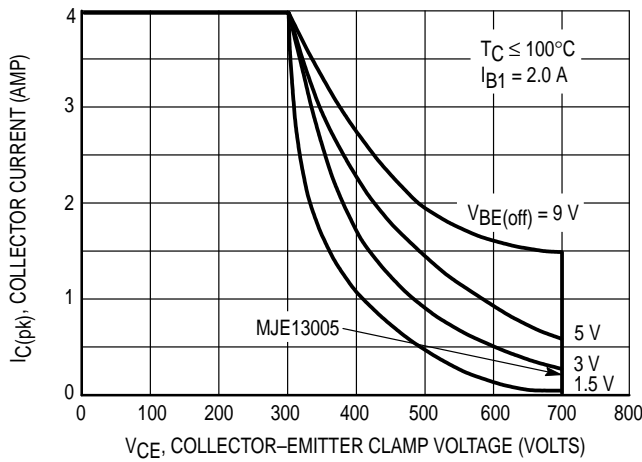

Figure 12. Reverse Bias Switching Safe Operating Area

## SAFE OPERATING AREA INFORMATION

### FORWARD BIAS

There are two limitations on the power handling ability of a transistor: average junction temperature and second breakdown. Safe operating area curves indicate  $I_C - V_{CE}$  limits of the transistor that must be observed for reliable operation; i.e., the transistor must not be subjected to greater dissipation than the curves indicate.

The data of Figure 11 is based on  $T_C = 25^\circ\text{C}$ ;  $T_{J(pk)}$  is variable depending on power level. Second breakdown pulse limits are valid for duty cycles to 10% but must be derated when  $T_C \geq 25^\circ\text{C}$ . Second breakdown limitations do not derate the same as thermal limitations. Allowable current at the voltages shown on Figure 11 may be found at any case temperature by using the appropriate curve on Figure 13.

$T_{J(pk)}$  may be calculated from the data in Figure 10. At high case temperatures, thermal limitations will reduce the power that can be handled to values less than the limitations imposed by second breakdown.

### REVERSE BIAS

For inductive loads, high voltage and high current must be sustained simultaneously during turn-off, in most cases, with the base to emitter junction reverse biased. Under these conditions the collector voltage must be held to a safe level at or below a specific value of collector current. This can be accomplished by several means such as active clamping, RC snubbing, load line shaping, etc. The safe level for these devices is specified as Reverse Bias Safe Operating Area and represents the voltage-current conditions during reverse biased turn-off. This rating is verified under clamped conditions so that the device is never subjected to an avalanche mode. Figure 12 gives the complete RBSOA characteristics.

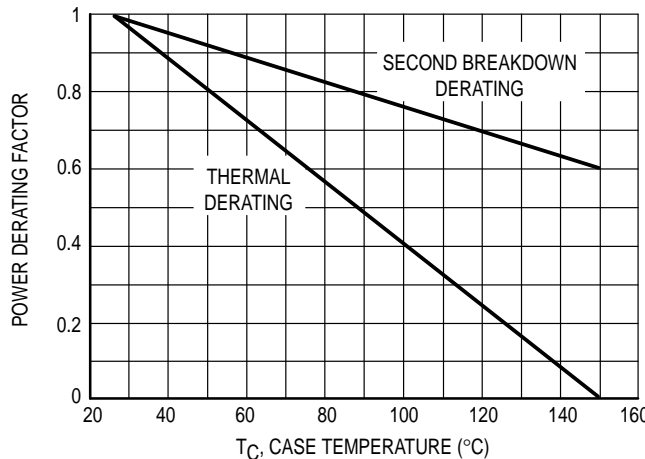
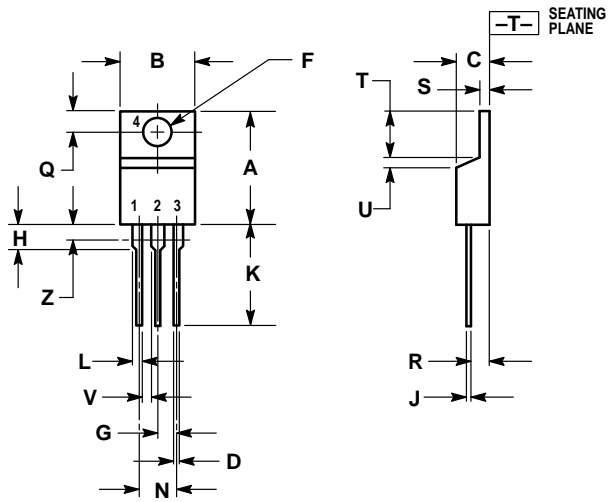

Figure 13. Forward Bias Power Derating

PACKAGE DIMENSIONS



- NOTES:
1. DIMENSIONING AND TOLERANCING PER ANSI Y14.5M, 1982.
  2. CONTROLLING DIMENSION: INCH.
  3. DIMENSION Z DEFINES A ZONE WHERE ALL BODY AND LEAD IRREGULARITIES ARE ALLOWED.

DIM	INCHES		MILLIMETERS	
	MIN	MAX	MIN	MAX
A	0.570	0.620	14.48	15.75
B	0.380	0.405	9.66	10.28
C	0.160	0.190	4.07	4.82
D	0.025	0.035	0.64	0.88
F	0.142	0.147	3.61	3.73
G	0.095	0.105	2.42	2.66
H	0.110	0.155	2.80	3.93
J	0.018	0.025	0.46	0.64
K	0.500	0.562	12.70	14.27
L	0.045	0.060	1.15	1.52
N	0.190	0.210	4.83	5.33
Q	0.100	0.120	2.54	3.04
R	0.080	0.110	2.04	2.79
S	0.045	0.055	1.15	1.39
T	0.235	0.255	5.97	6.47
U	0.000	0.050	0.00	1.27
V	0.045	—	1.15	—
Z	—	0.080	—	2.04

- STYLE 1:  
 PIN 1. BASE  
 2. COLLECTOR  
 3. EMITTER  
 4. COLLECTOR

CASE 221A-06  
 TO-220AB  
 ISSUE Y

Motorola reserves the right to make changes without further notice to any products herein. Motorola makes no warranty, representation or guarantee regarding the suitability of its products for any particular purpose, nor does Motorola assume any liability arising out of the application or use of any product or circuit, and specifically disclaims any and all liability, including without limitation consequential or incidental damages. "Typical" parameters can and do vary in different applications. All operating parameters, including "Typicals" must be validated for each customer application by customer's technical experts. Motorola does not convey any license under its patent rights nor the rights of others. Motorola products are not designed, intended, or authorized for use as components in systems intended for surgical implant into the body, or other applications intended to support or sustain life, or for any other application in which the failure of the Motorola product could create a situation where personal injury or death may occur. Should Buyer purchase or use Motorola products for any such unintended or unauthorized application, Buyer shall indemnify and hold Motorola and its officers, employees, subsidiaries, affiliates, and distributors harmless against all claims, costs, damages, and expenses, and reasonable attorney fees arising out of, directly or indirectly, any claim of personal injury or death associated with such unintended or unauthorized use, even if such claim alleges that Motorola was negligent regarding the design or manufacture of the part. Motorola and  are registered trademarks of Motorola, Inc. Motorola, Inc. is an Equal Opportunity/Affirmative Action Employer.

**How to reach us:**

**USA / EUROPE:** Motorola Literature Distribution;  
P.O. Box 20912; Phoenix, Arizona 85036. 1-800-441-2447

**JAPAN:** Nippon Motorola Ltd.; Tatsumi-SPD-JLDC, Toshikatsu Otsuki,  
6F Seibu-Butsuryu-Center, 3-14-2 Tatsumi Koto-Ku, Tokyo 135, Japan. 03-3521-8315

**MFAX:** RMFAX0@email.sps.mot.com – TOUCHTONE (602) 244-6609  
**INTERNET:** <http://Design-NET.com>

**HONG KONG:** Motorola Semiconductors H.K. Ltd.; 8B Tai Ping Industrial Park,  
51 Ting Kok Road, Tai Po, N.T., Hong Kong. 852-26629298

